

# MAXALTO

PARIS 19<sup>TH</sup> JANUARY 2023

# NEW PRODUCTS

Paris Jan 2023

# ARBITER



## Major modular system

As an immobile spectator of the indoor living landscape and events, Arbiter makes its presence felt in every home it enters thanks to its extra-large sizes wisely counterbalanced by the stylistic essentiality of the rigorous, almost archetypal lines of its design, conceived to lighten their impact in the domestic context.

Nine elements, in different sizes and in various configurations, also in the one with discontinuous backrest so dear to Antonio Citterio, fill the lack of big and large modular sofas in the Maxalto Collection and also the space and furnishing needs of the large impressive bourgeois houses.





## Metal and textile profiles

Created with the ambition of renewing and reinterpreting the tradition of the sofas made by master upholsterers and of interior design icons, Arbiter's rigorous design is underlined by its metal profiles available in the four options of the Maxalto metal finishings range: amber, graphite, nickel bronzed and black chromed painted aluminum.

Textile profiles also strengthen the design of its lines and enrich the covers and the cushions of the collection with a sophisticated detail that will be a fabric or leather piping always in matching tone and materials with the covers and a Bellano fabric piping, available in this case in all the colours range, on the velvet ones.

## Back cushions

To emphasize the generosity of the collection, back cushions are oversized in a new 70cm x 70cm format.

A surprising unusual solution is hidden in the way they are arranged on the sofa: in each couple, the small one (60cm x 60cm) is behind the larger one (70cm x 70cm) which thus becomes a sort of additional backrest that wraps around the shoulders of those who sit.



## TECHNICAL DETAILS

### LINEAR SOFA

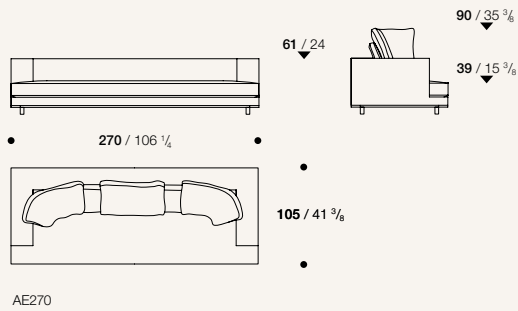

### TERMINAL ELEMENTS

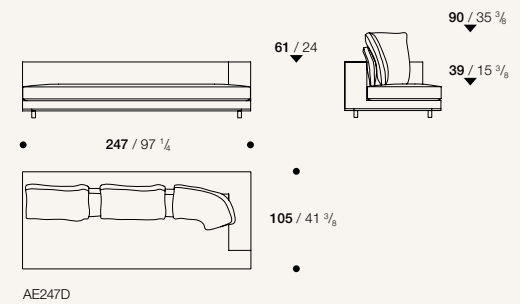
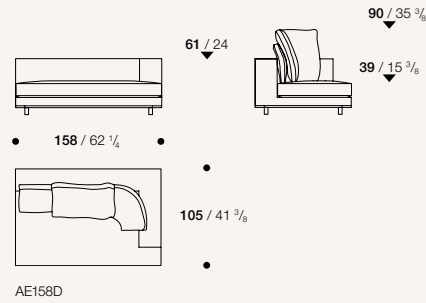
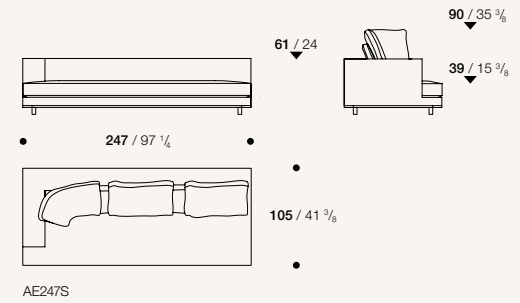
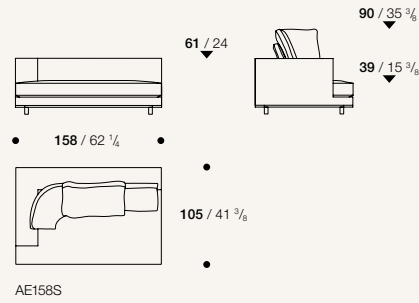



## TECHNICAL DETAILS

### CHAISE LONGUE

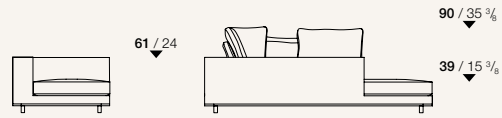

• 115 / 45 1/4 •

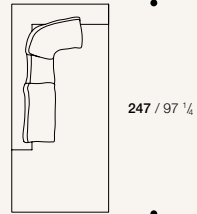

AE247LS

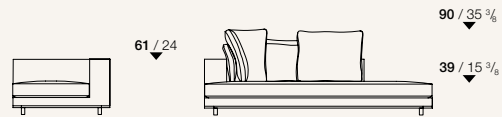

• 115 / 45 1/4 •

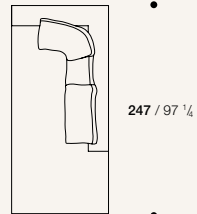

AE247LD

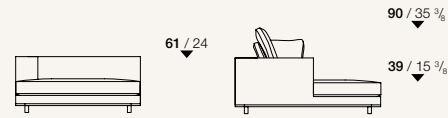

• 135 / 53 1/8 •

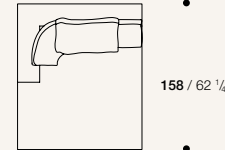

AE158LS

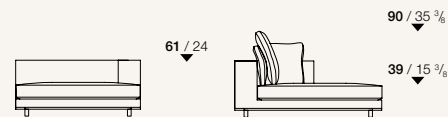

• 135 / 53 1/8 •

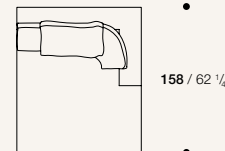

AE158LD

### CORNER ELEMENTS

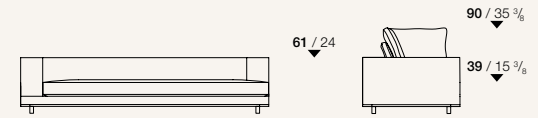

• 270 / 106 1/4 •

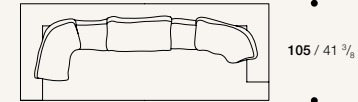

AE270AS

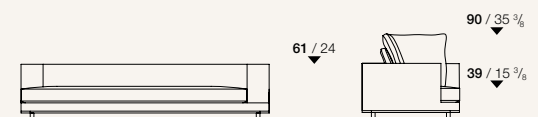

• 270 / 106 1/4 •

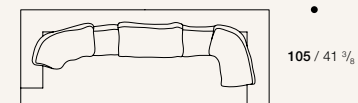

AE270AD

## FINISHES

### Lower edge

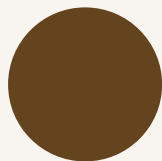

0137A  
AMBER  
PAINTED



0252G  
GRAPHITE  
PAINTED



0174B  
BRONZED NICKEL  
PAINTED



0170M  
BLACK CHROMED  
PAINTED

### Cover



FABRIC



LEATHER

LILUM





## Organic gentle shapes

Characterized by sinuous lines of natural inspiration as the floral ones of a Lily petal, Lilum is specifically designed for solutions of conviviality and intimacy and to cohabit, therefore, in the same environment with other more formal sofas.

The soft and curved shapes of Lilum create indeed a relaxed atmosphere in the home and its more or less compacted dimensions facilitate conversations among guests, offering the (five) persons sitting on it pleasant sharing moments.

## Unconventional beauty



Single direct seat collection within Maxalto brand, Lilum has a range of elements made up by terminals, chaise longues or dorneuses with more or less compacted dimensions that facilitate unconventional but harmonic layouts in the space.

There is no need for back cushions as the softness of the shapes of the backrest and the particular seat construction with down-filled insert, make Lilum comfortable and enjoyable.

## Metal and textile profiles



The extruded aluminum profile in various finishes draws the ground line and defines the contour with a touch of sober refinement.

Precious pipings in the same colour as the fabric or leather enhance the beauty of the curvilinear outline of the elements of this collection and emphasize the large edge between the base and the seat, recalling the sofas of the artisanal tradition.

## TECHNICAL DETAILS

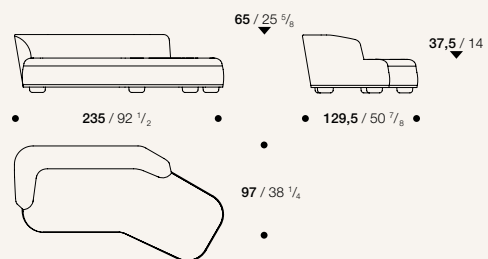

LIL235S

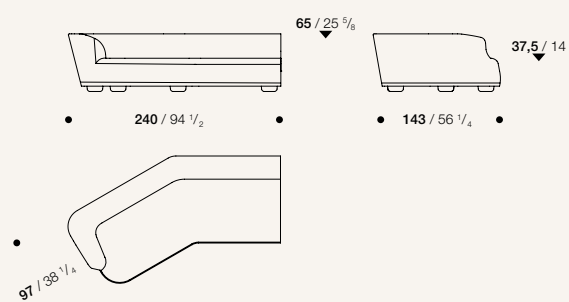

LIL240TS

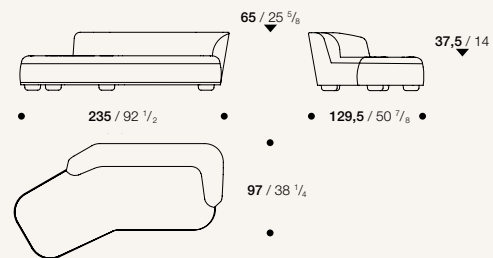

LIL235D

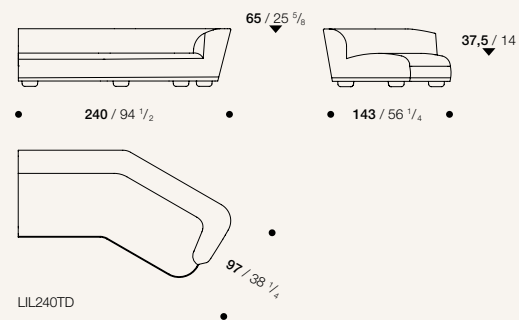

LIL240TD



## TECHNICAL DETAILS

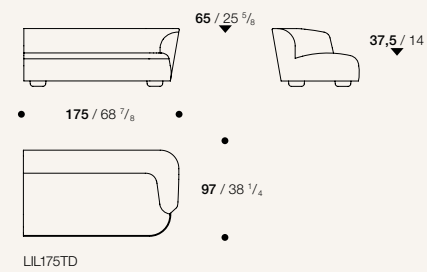
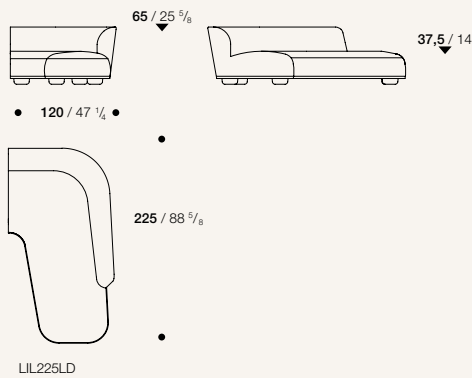
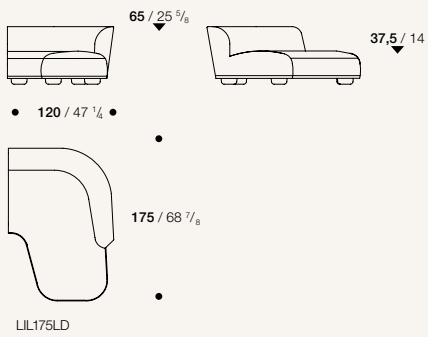
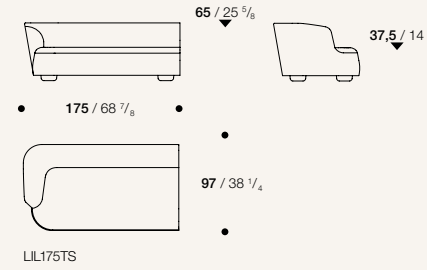
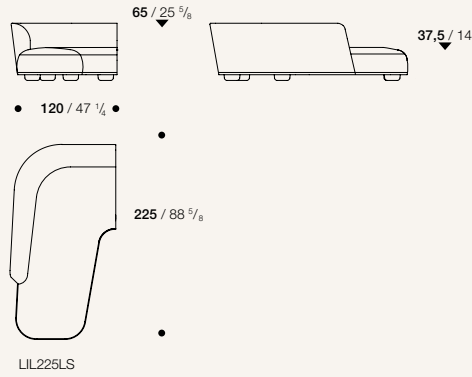
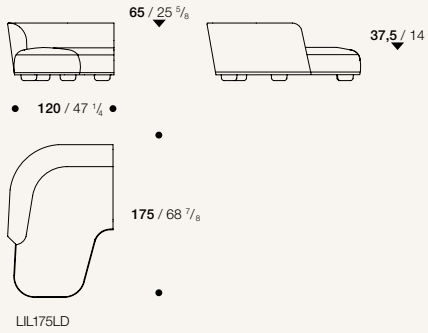

## FINISHES

### Lower edge

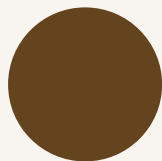

0137A  
AMBER  
PAINTED



0252G  
GRAPHITE  
PAINTED



0174B  
BRONZED NICKEL  
PAINTED



0170M  
BLACK CHROMED  
PAINTED

### Cover



FABRIC



LEATHER

CLEIDE, DESPINA

## Cleide



Together with Despina, Cleide is daughter of the re-edition and modernisation of two chairs designed by Antonio Citterio at the dawn of Maxalto's trajectory.

Authentic expressions of the Maxalto's artisan spirit and craftsmanship in woodworking, they have been updated in terms of their materials, production technique and sizes to adapt to the evolution of the living spaces. Particularly remarkable is the backrest curved construction with battens.

Noble solid wood frames can be in grey, brushed light and brushed black oak variants, while the seat has not-removable covers in fabric or leather.

## Despina



Together with Cleide, Despina is daughter of the re-edition and modernisation of two chairs designed by Antonio Citterio at the dawn of Maxalto's trajectory.

Authentic expressions of the Maxalto's artisan spirit and craftsmanship in woodworking, they have been updated in terms of their materials, production technique and sizes to adapt to the evolution of the living spaces.

Noble solid wood frames can be in grey, brushed light and brushed black oak variants, while the seat has not-removable covers in fabric or leather. The sinuous lines of the armrests are a distinctive feature of Despina.

## TECHNICAL DETAILS

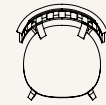
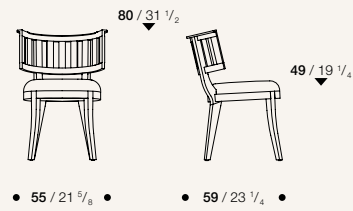

CE55S

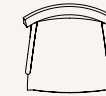
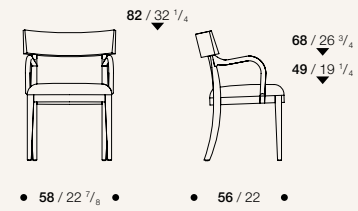

DES58SB

## FINISHES

### Frame



0374C  
BRUSHED  
LGHT OAK



0378G  
GREY OAK



0381N  
BRUSHED  
BLACK OAK

SILEO

## Refined Style



With personal features halfway between a refined style and a more simple, almost hotel-inspired sommier, it widens the Maxalto range of beds.

Sileo's shapes are slightly rounded without being cumbersome. Although minimal in style, the headboard is very high, designed to define the space but also to accommodate the occupants' heads and shoulders while reading, even with high, flush-fitting mattresses.

Characterized by an aluminium profile in different colours, it is available in five sizes (queen and king size included) with fabric or leather covers.

The frame can accommodate different slatted base systems and either a semi-recessed or flush mattress.



## TECHNICAL DETAILS

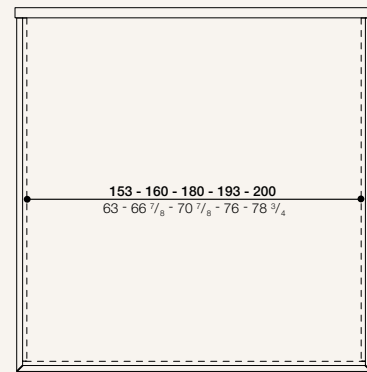
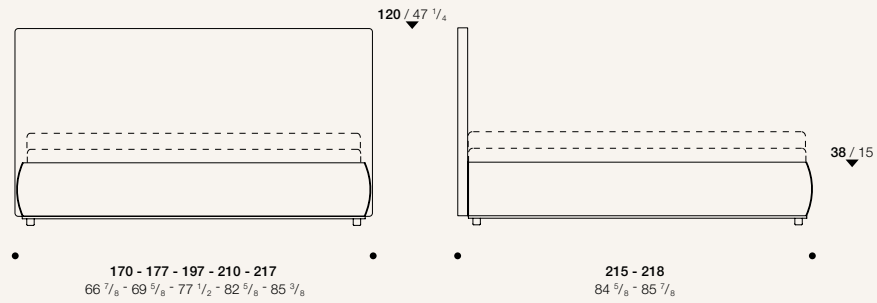

LSE

## FINISHES

### Lower edge

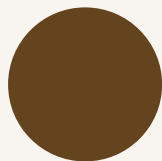

0137A  
AMBER  
PAINTED



0252G  
GRAPHITE  
PAINTED



0174B  
BRONZED NICKEL  
PAINTED



0170M  
BLACK CHROMED  
PAINTED

### Cover



FABRIC



LEATHER

# PRIVATUS

## Exclusive screen



Only a complementary piece in appearance, this screen responds to the need to define the spaces in large rooms of stately homes;

for example this can be used between reception and dining areas (version with 3 or 4 panels), or behind the headboard of the bed to outline the sleeping area (version with 8 panels).

Besides dividing and defining the spaces it also has a decorative function and helps create interesting backdrops to bring some products out of the environment.

## Precious details



The panels feature an unedited hand-made material composed for 50% by raffia, a fiber similar to straw that is extremely hardy, slightly sound absorbent and has a tangible materiality without being intrusive.

The remaining 50% is composed of banana leaves then applied on a non-woven fabric to give it more stability .

These particular fibers have been selected for their raw and natural look and the richness of their imperfections.

## TECHNICAL DETAILS

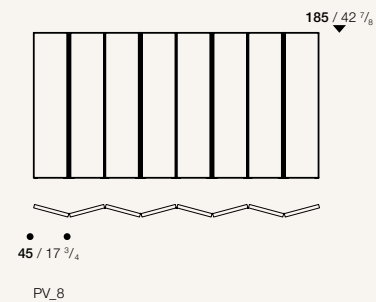
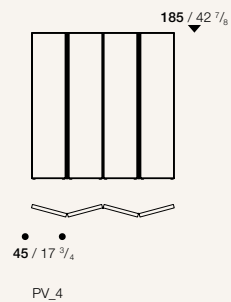
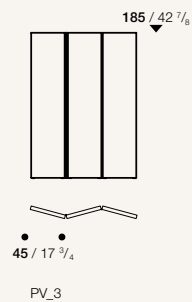

## FINISHES

Panel cover

Peripheral edge



0651C  
LIGHT COLOUR  
RAFFIA



0723S  
DARK COLOUR  
RAFFIA

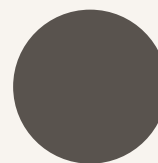

0174B  
BRONZED NICKEL  
PAINTED

# TEXTILE COLLECTION

## Fabrics



Since 2020 Maxalto brand has a dedicated textile collection that make its style manifest and distinctive.

The 2023 fabrics collection will add new tones to the black and white, broadening the soft colors palette. Ecu, beige, camel and tobacco nuances are the warm and pale protagonists of the parisian debut.



## FABRICS

### DORIS



2830280

2830102

#### Composition

MODAL	32%
ACRYLIC	24%
COTTON	22%
VISCOSE	10%
WOOL	8%
POLYAMIDE	4%

#### Fabric flame resistance

BS 5852 - 0&1  
TB 117 - 2013

### DALLAS



2831259

2831373

2831421

#### Composition

COTTON	63%
POLYESTER	28%
ACRYLIC	7%
OTHER FIBERS	2%

#### Fabric flame resistance

BS 5852 - 0&1

## FABRICS

### DELIA



2832925

#### Composition

COTTON	74%
ACRYLIC	22%
VISCOSE	4%

Fabric flame resistance  
BS 5852 - 0

### LONDRA



2833150



2833153



2833102



2833313

#### Composition

COTTON	96%
MODAL	4%

Fabric flame resistance  
BS 5852 - 0&1

## FABRICS

### DIANA



2834775



2834280



2833102

#### Composition

WOOL	41%
VIRGIN WOOL	40%
COTTON	16%
POLYESTER	2%
POLYAMIDE	1%

#### Fabric flame resistance

BS 5852 - 0&1  
TB 117 - 2013

### MILO – range extension



2440132



2440313

#### Composition

Fur	
WOOL	100%
Base	
WOOL	64%
COTTON	26%

#### Fabric flame resistance

BS 5852 - 0&1  
TB 117 - 2013

# Carpet

## DIAKOS

Rectangular in shape, in three sizes, 100% wool, the carpet is part of Maxalto's strategy of expanding its textile offering. With an easy maintenance, and high durability and resistance, it is a perfect choice also for contract projects.



0044T DOVE GREY COLOUR

## Plaid

### AFRATO

All-over printed plaid with a big Maxalto logo available in four colours. The jacquard technology allowed the realization of the almost geometrical pattern.



2835130 NATURAL/BROWN  
2835140 NATURAL/GREEN  
2835150 NATURAL/YELLOW  
2835175 NATURAL/RUST

### MALAKOS

Bicolor plaid with degradè edges and Maxalto logo. Available in four colors with the logo always in matching tone.



2836320 BROWN/BEIGE  
2836420 GREEN/BEIGE  
2836520 YELLOW/BEIGE  
2836720 RUST/BEIGE

## Bed runner and decorative pillow

### ZESTOS

Bedrunner 140x250 cm with a colored band highlighting the Maxalto logo.  
Decorative 45x65cm pillows in Merino wool and cashmere help the bedrunner to adorn the bed.  
A precious cashmere bouclè thread gives softness and richness to this contemporary plaid that enriches the bed.  
Available in two colors with five color options for the band.



2837230	BEIGE WITH BROWN STRIPE	2837130	GREY WITH BROWN STRIPE
2837240	BEIGE WITH GREEN STRIPE	2837140	GREY WITH GREEN STRIPE
2837265	BEIGE WITH YELLOW STRIPE	2837165	GREY WITH YELLOW STRIPE
2837277	BEIGE WITH RUST STRIPE	2837177	GREY WITH RUST STRIPE
2837223	BEIGE WITH CAMEL STRIPE	2837155	GREY WITH GREY STRIPE

NEW RANGE EXTENSIONS

# AMOENUS SOFT



## New dimension

A true icon of Maxalto collection.

After the first redefinition in 2020 that revamped its look and comfort, the Amoenus Soft sofa is now declined in a new dimension (ø140cm) that comply with an international markets request.

A new option for the most tasteful interior decorators worldwide is now available.



## TECHNICAL DETAILS

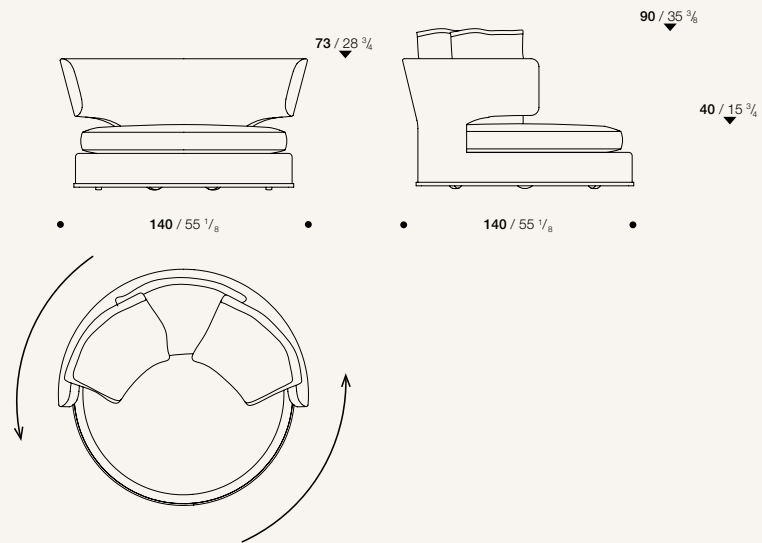

AM140G

## FINISHES

### Lower edge



0137A  
AMBER  
PAINTED



0252G  
GRAPHITE  
PAINTED



0174B  
BRONZED NICKEL  
PAINTED



0170M  
BLACK CHROMED  
PAINTED

### Eco-leather profiles

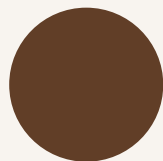

1130350  
DARK BROWN

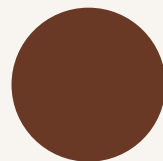

1130300  
BROWN



1130255  
DARK GREY



1130280  
DOVE GREY



1130203  
ROPE

### Cover



FABRIC



LEATHER

LOTO



## New dimension

The range of oriental-inspired small, night tables is enriched with a new, taller size, designed to accompany a high mattress.

The latest addition retains the distinctive feature of the curved staves that lighten its frame, but also presents a new characteristic:

it can be combined with a tray that fits perfectly on the table top, ideal for serving breakfast in bed or a cocktail on the sofa.

All the pieces in the Loto range are made of solid wood and are available in various finishes or painted with a shellac effect. The tray is available in grey, brushed light and brushed black oak variants or shellac in three colours.

## TECHNICAL DETAILS

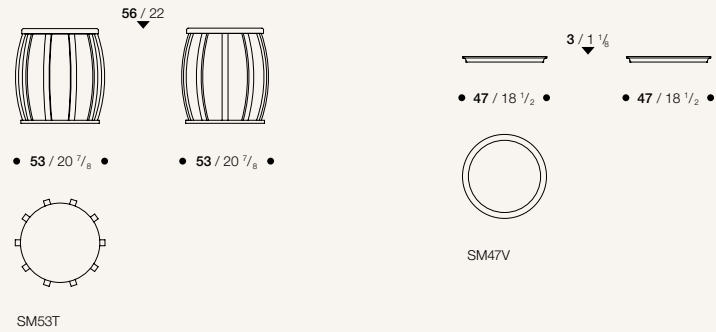

## FINISHES

### Frame and tray



0374C  
BRUSHED  
LGHT OAK



0378G  
GREY OAK

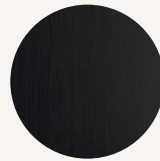

0381N  
BRUSHED  
BLACK OAK

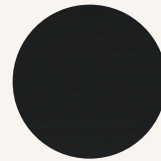

3764G  
BLACK SHELLAC

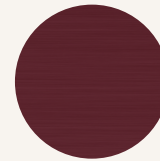

7110G  
RED SHELLAC

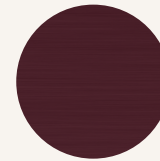

6805G  
SOIA SHELLAC

# ELIOS



## New dimension

The new addition to this series of small tables, with a circular base and vertical steel uprights in different finishes, is designed specifically to be placed in front of the sofa or right at the break in the sofa backrest. Ideal for resting your tablet, diary or cocktail on.

It now comes with the top always in black back-painted smoky glass in a new oval or round shape, with or without the relevant removable tray, which comes in different finishes of oak or shellac.



## TECHNICAL DETAILS

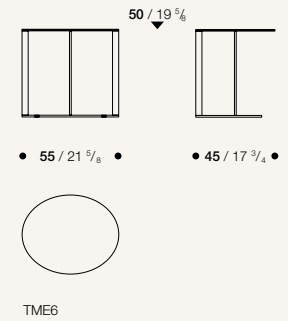
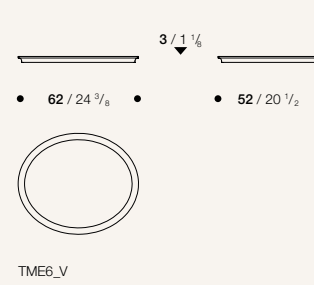
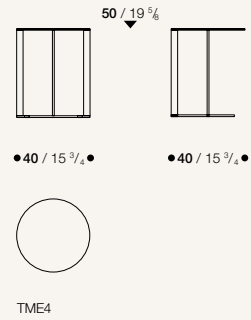
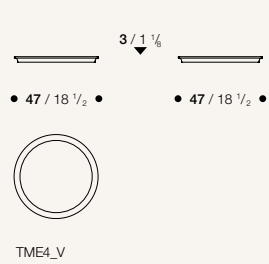

## FINISHES

### Small table frame



0170M  
BLACK  
CHROMED  
PAINTED



0252G  
GRAPHITE  
PAINTED

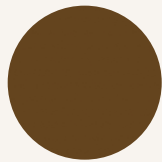

0137A  
AMBER  
PAINTED

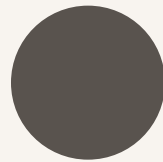

0174B  
BRONZED  
NICKEL PAINTED

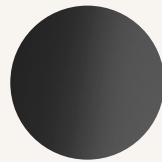

0140F  
BLACK  
BACK-PAINTED  
SMOKY GLASS



0374C  
BRUSHED  
LGHT OAK



0378G  
GREY OAK



0381N  
BRUSHED  
BLACK OAK

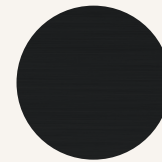

3764G  
BLACK  
SHELLAC

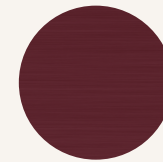

7110G  
RED  
SHELLAC

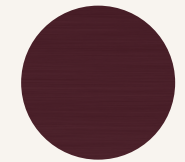

6805G  
SOIA  
SHELLAC

### Small table top Tray

# MAXALTO RETAIL IDENTITY







Logos



Backlights



Styling



Flooring



Boiserie/Walls



Freestanding boiserie screen



Working Area

THANK YOU

PARIS 19<sup>TH</sup> JANUARY 2023



*MILANO 2023*  
APRIL 18TH-23RD



**MAXALTO**

MAXALTO 2023

*An important year*

NEW PRODUCTS & TEXTILE COLLECTION

*Paris 2023*

NEW RANGE EXTENSIONS

*Milan 2023*

Caratos

Eracle

Tesaurus

Recipio '14

New Finish Range Extensions

TEXTILE COLLECTION

*Milan 2023*

LAYOUT PROPOSALS

MARKETING AND COMMUNICATION

Delivery terms

Communication updates

Event plan & info

**MAXALTO**

MAXALTO 2023  
*An important year*

BRAND DISTINCTIVENESS  
·  
FOCUS ON BRAND AWARENESS  
·  
NEW ORGANIZATION  
·  
EVOLUTION OF THE BRAND DISTRIBUTION

NEW PRODUCTS & TEXTILE COLLECTION  
*Paris 2023*

Arbiter, Elios



# Lilum



Cleide, Despina



Sileo, Privatus, Loto





## Amoenus Soft, Textile Collection



NEW RANGE EXTENSIONS  
*Milan 2023*

# CARATOS



## Caratos



One of the most important additions in 2023 is this family of seating with its characteristic die-cast aluminium structure. There are three new elements that stand out thanks to their backrest: rectangular, shield - and bean - shaped. They are all characterized by a high upholstered seat cushion that grants a comfortable seat.

## Caratos

The extension of the Caratos line is the result of Antonio Citterio's original design, which already envisaged the possibility of producing a lower trestle combined with a correspondingly higher upholstery and backrest.



## Caratos



In particular, the version with the bean-shaped back is designed specifically for restaurants and hôtellerie, to place for example in front of a dressing-table or desk.

## TECHNICAL DETAILS

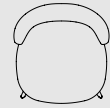
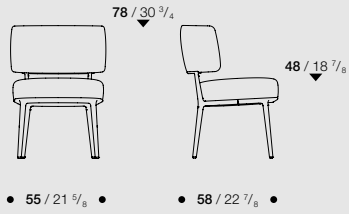

CAR55

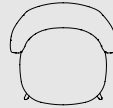
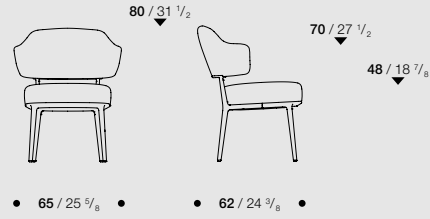

CAR65

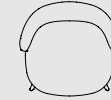
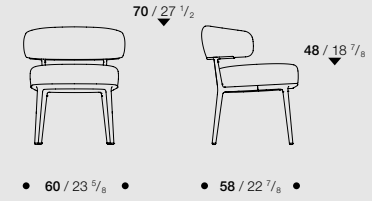

SCA57B\_SA

## FINISHES

Support frame

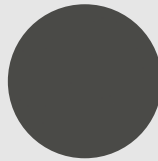

0252G  
GRAPHITE  
PAINTED

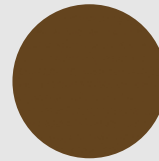

0137A  
AMBER  
PAINTED



ERACLE



## Eracle



For years the star of the Maxalto range for the bedroom, the wardrobe is now presented in a new “display” version with glass doors and sides, making it a real showcase for clothing. The inside is embellished with a dark-coloured rafia back panel, a style choice also designed to lend more solidity to the interiors.

## TECHNICAL DETAILS

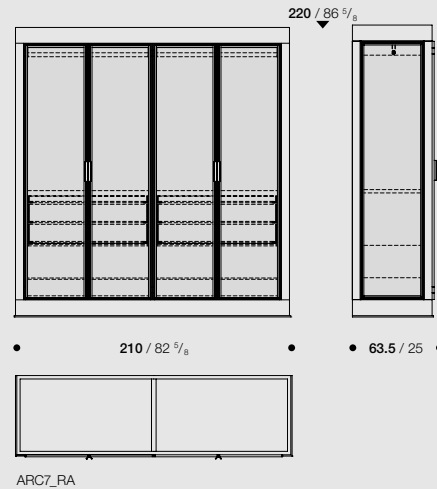

## FINISHES

Hinged doors  
and lateral sides



0121A  
COUPLED TRANSPARENT  
GLASS WITH BRONZED  
METAL HIGH-TECH  
INTERNAL FABRIC

Back panel



0723S  
DARK COLOUR  
RAFFIA

External frame



0378G  
GREY OAK



0374C  
BRUSHED  
LIGHT OAK



0381N  
BRUSHED  
BLACK OAK

Internal frame



0398A  
COLONIALE  
LEATHER  
MELAMINE FACED

Chest of drawers top  
and clothes rail

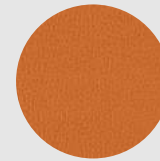

AF571  
COLONIALE  
ALFA LEATHER

Doors profile, multipurpose  
shoes rack, chest of drawer  
frame and fronts

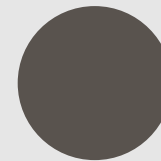

0174B  
BRONZED NICKEL  
PAINTED

# TESAURUS



## Tesaurus



The Tesaurus family of high cabinetry storage units introduces a new variant for the 90 cm wide element. Inspired by traditional large travel trunks, it takes the original Maxalto logo of the 70s and uses it as a pattern, repeated across the entire surface and finished with a glossy polyester varnish. The result is an iconic and highly refined piece.

## TECHNICAL DETAILS

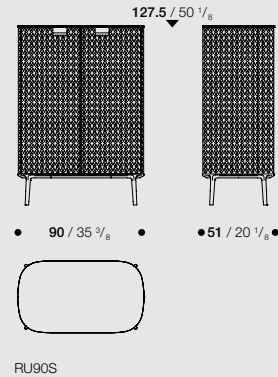

## FINISHES

External frame



0774S  
GLOSSY LACQUERED  
GRAPHIC DECORATION

Internal frame  
and shelves

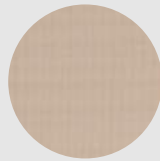

0351A  
MAPLE FRISÉ

Upper top



0955M  
MARQUINIA BLACK  
MARBLE WITH MATT  
POLYESTER FINISH



0184O  
CALACATTA WHITE  
MARBLE WITH MATT  
POLYESTER FINISH

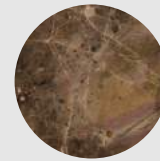

0891E  
EMPERADOR  
MARBLE WITH MATT  
POLYESTER FINISH

Base-frame and handles

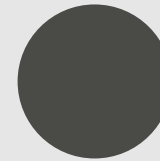

0252G  
GRAPHITE  
PAINTED

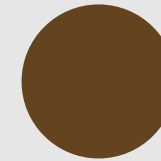

0137A  
AMBER  
PAINTED



## RECIPIO '14

## Recipio '14



The eclectic night/small table is now even more functional thanks to a half-height drawer that is particularly handy next to a bed, for storing magazines, books and other small items that accompany sleeping and reading.

## TECHNICAL DETAILS

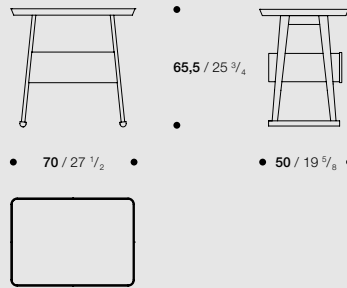

LXC17

## FINISHES

Support frame and drawer

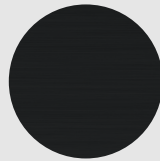

3764G  
SHELLAC TYPE  
FINISH BLACK

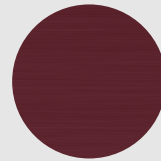

7110G  
SHELLAC TYPE  
FINISH RED

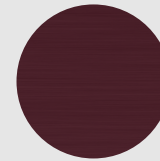

6805G  
SHELLAC TYPE  
FINISH SOYA

NEW FINISH RANGE EXTENSIONS

## New Finish Range Extension



Maxalto wood essences lineup sees the introduction of the new white rough cut oak finishing that will brighten up Maxalto's settings with inherited brights shades. This new wood finishing will be available on a limited selection of products only.

## NEW FINISH RANGE EXTENSIONS



0354B  
WHITE ROUGH  
CUT OAK

ASTRUM  
tables  
MAX  
desk tables  
LITHOS  
small tables  
ERACLE  
bookcase  
ALCOVA  
beds and night tables



0354B  
WHITE ROUGH CUT OAK

External finish

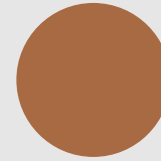

4232L  
GLOSSY TOBACCO

Internal finish

MIDA  
storage units  
and sideboard

TEXTILE COLLECTION  
*Milan 2023*

## FABRICS



# Fabrics

Maxalto is also introducing a new range of fabrics that expands the line created in 2020. The new materials aim to give upholstered furniture an even more sophisticated look, with special decorations and finishes and the characteristic tactile consistency of velvet, jacquard, and bouclé.

## FABRICS

### DOKOS



2841102



2841280



2841313

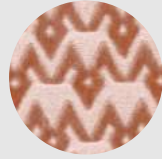

2841370



2841421



2841500

#### Composition

VISCOSE	40%
POLYESTER	32%
COTTON	28%

Fabric flame resistance  
BS 5852 - 0&1

### LOREN



2838106



2838207

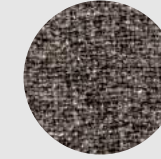

2838257

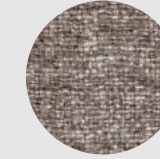

2838280

#### Composition

WOOL	50%
LINEN	37%
POLYESTER	13%

Fabric flame resistance  
BS 5852 - 0&1  
TB 117 - 2013

## FABRICS

### DORIS – range extension



2830132



2830313

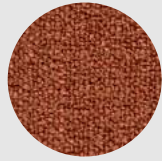

2830370



2830421



2830500

### DIANA – range extension



2834207

#### Composition

MODAL	32%
ACRYLIC	24%
COTTON	22%
VISCOSE	10%
WOOL	8%
POLYAMIDE	4%

#### Fabric flame resistance

BS 5852 - 0&1  
TB 117 - 2013

#### Composition

WOOL	41%
VIRGIN WOOL	40%
COTTON	16%
POLYESTER	2%
POLYAMIDE	1%

#### Fabric flame resistance

BS 5852 - 0&1  
TB 117 - 2013

## FABRICS

### SAFFIRA – range extension

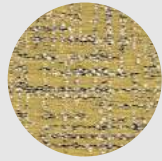
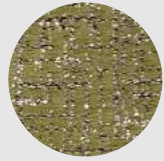
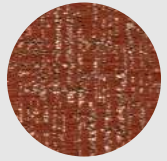

2610360

2610440

2610500

#### Composition

POLYESTER	49%
COTTON	32%
ACRYLIC	16%
POLYAMIDE	3%

#### Fabric flame resistance

BS 5852 - 0&1  
TB 117 - 2013

### LILLE – range extension

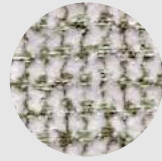
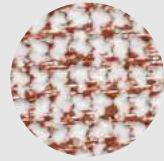

2598322

2598442

#### Composition

POLYESTER	43%
VISCOSE	42%
POLYAMIDE	15%

#### Fabric flame resistance

TB 117 - 2013

### LOU – range extension

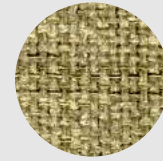
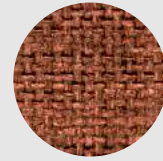

2613360

2613440

2613500

#### Composition

VISCOSE	47%
COTTON	19%
POLYESTER	18%
POLYAMIDE	12%
LINEN	4%

#### Fabric flame resistance

BS 5852 - 0&1  
TB 117 - 2013

## FABRICS

### LOSANNA – range extension

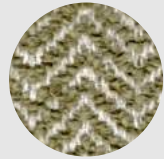

2622132

2622313

2622370

2622421

2622500

#### Composition

VISCOSE	38%
WOOL	28%
COTTON	23%
ACRYLIC	10%
POLYAMIDE	1%

#### Fabric flame resistance

BS 5852 - 0&1  
TB 117 - 2013

### LIVERI – range extension



2596132

#### Composition

WOOL	49%
COTTON	34%
VISCOSE	7%
POLYAMIDE	6%
ACRYLIC	4%

#### Fabric flame resistance

BS 5852 - 0&1  
TB 117 - 2013

## FABRICS

### LONDRA – range extension



2833151

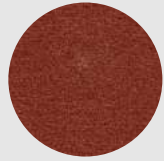

2833370



2833440



2833500

#### Composition

COTTON	96%
MODAL	4%

Fabric flame resistance  
BS 5852 - 0&1

### MILO – range extension



2540370

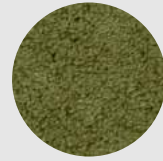

2540400



2540500

#### Composition

Fur	
WOOL	100%
Base	
WOOL	64%
COTTON	26%

Fabric flame resistance  
BS 5852 - 0&1  
TB 117 - 2013

# PLAID

## Mabon



Made from 100% Merino wool, this blanket has a strong tactile quality. Decorated with the embossed Maxalto logo repeated over the entire standard size of 140×180 cm, it is specifically designed for a sofa or armchair.



## TECHNICAL DETAILS

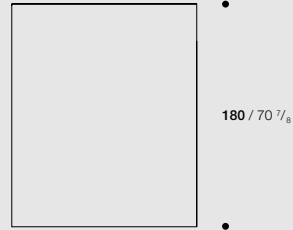

• 140 / 55 1/8 •

PMB140\_18

## COLORS



2843102  
ECRU

# CARPETS

## Diakos

Pure wool carpets featuring the historic Maxalto logo repeated as a decorative pattern over the entire surface. It now comes in two new colours.

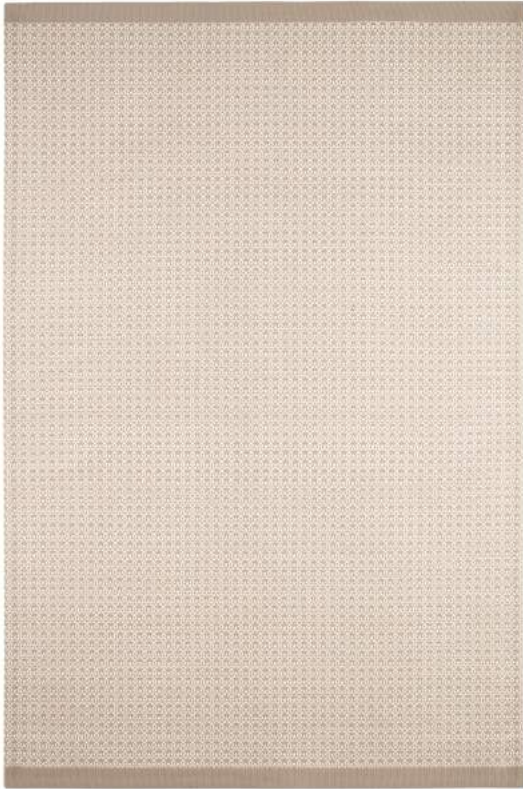

## TECHNICAL DETAILS

New range extension

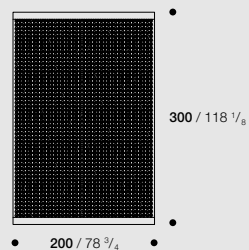

DK2T

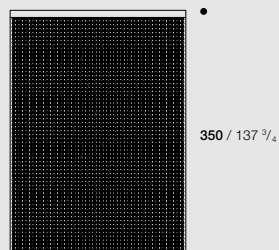

DK3T

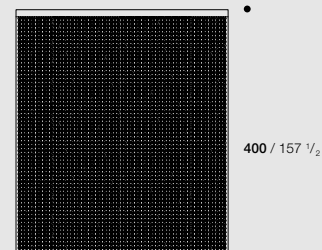

DK4T

## COLORS



0052S  
SAND



0098N  
BLACK

## Siglum



Hand-tufted mohair carpet in three color variants - ecru, tobacco and beige - with ton sur ton Maxalto logo in relief. The range includes a rectangular version in three sizes and a round version in one size. It can also be made to measure.

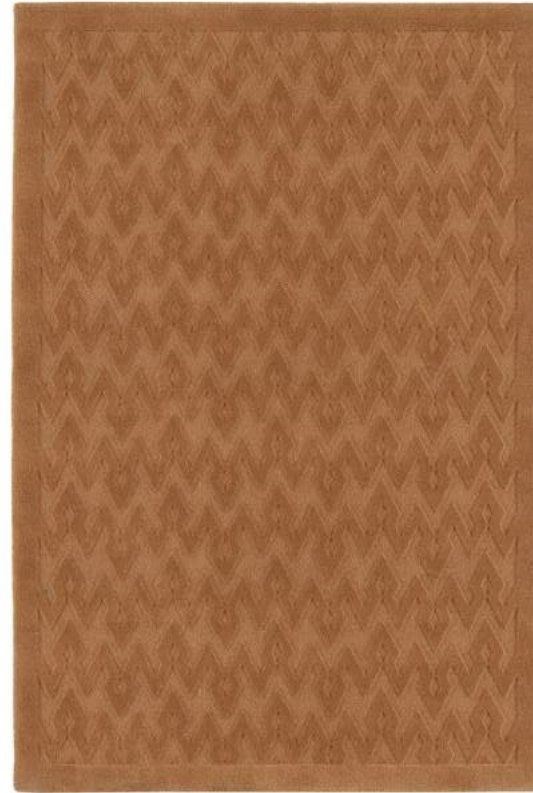

## TECHNICAL DETAILS

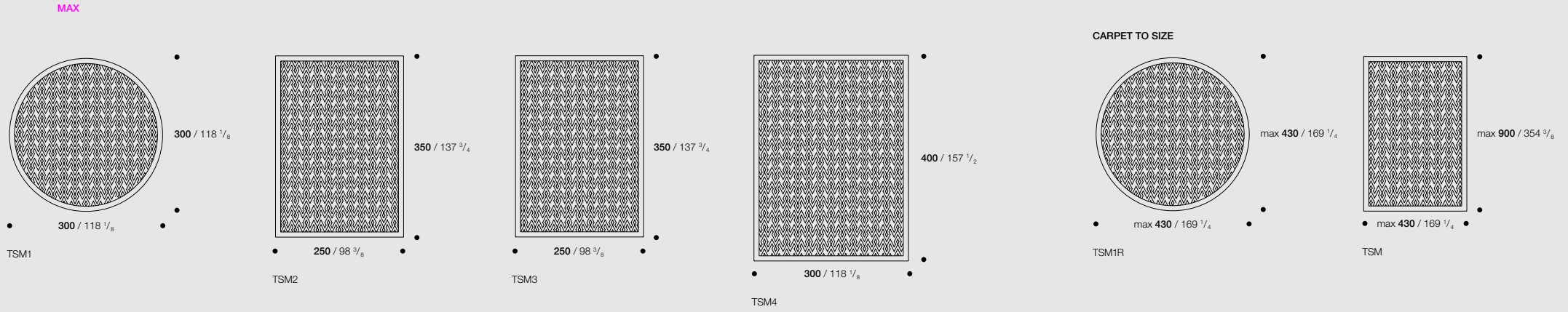

## COLORS

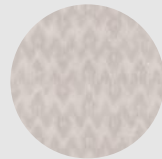

0073E  
ECRU

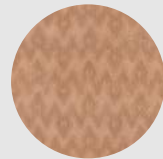

0088C  
CAMEL

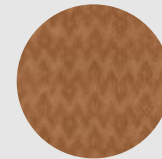

0093T  
TOBACCO